



NERINEA



ESSENCE | FLOW | EROSION | UNIQUE COLLECTION



ESSENCE

design: Miguel Herranz

Essence es un diseño que mediante volúmenes básicos resalta la contundencia de la piedra, el volumen de partida, la fuerza de la piedra... la esencia de la piedra. Es un diseño amable y entendible que se integra fácilmente en todo tipo de ambientes.

The design of the Essence Stone Sink draws on elemental forms to emphasize the power of the stone: its original volume, its strength, its essence. The friendly, accessible design fits seamlessly into all kinds of environments.



ESSENCE



El mecanizado mediante robot de esta pieza consigue resaltar la nobleza y la pureza proveniente del bloque original, desvelando a través de su volumen la esencia natural de la piedra.

The robotic machining of the piece brings out the elegance and purity of the original block, with its form revealing the natural essence of the stone.





La amplia gama de piedras que ofrece Nerinea abre un abanico de posibilidades a la hora de confeccionar el lavabo, confiriéndole una personalidad diferente según la piedra utilizada. Se ofrece tanto en versión de sobremesa como de pared.

Nerinea provides a wide selection of natural stone, which opens up myriad possibilities when it comes to crafting the sink, with each choice of stone revealing a different personality. The Essence sink is available in both vessel and wall-mounted versions.

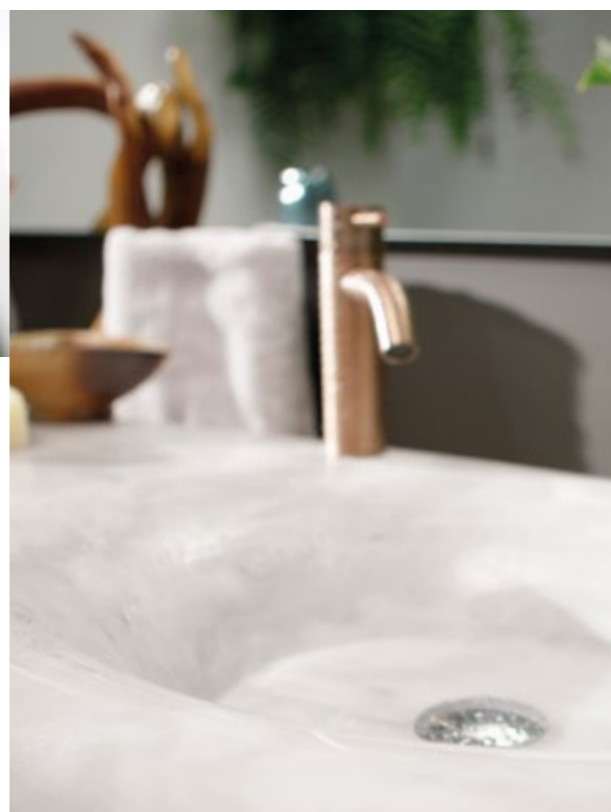

ESSENCE



ESSENCE

ESSENCE

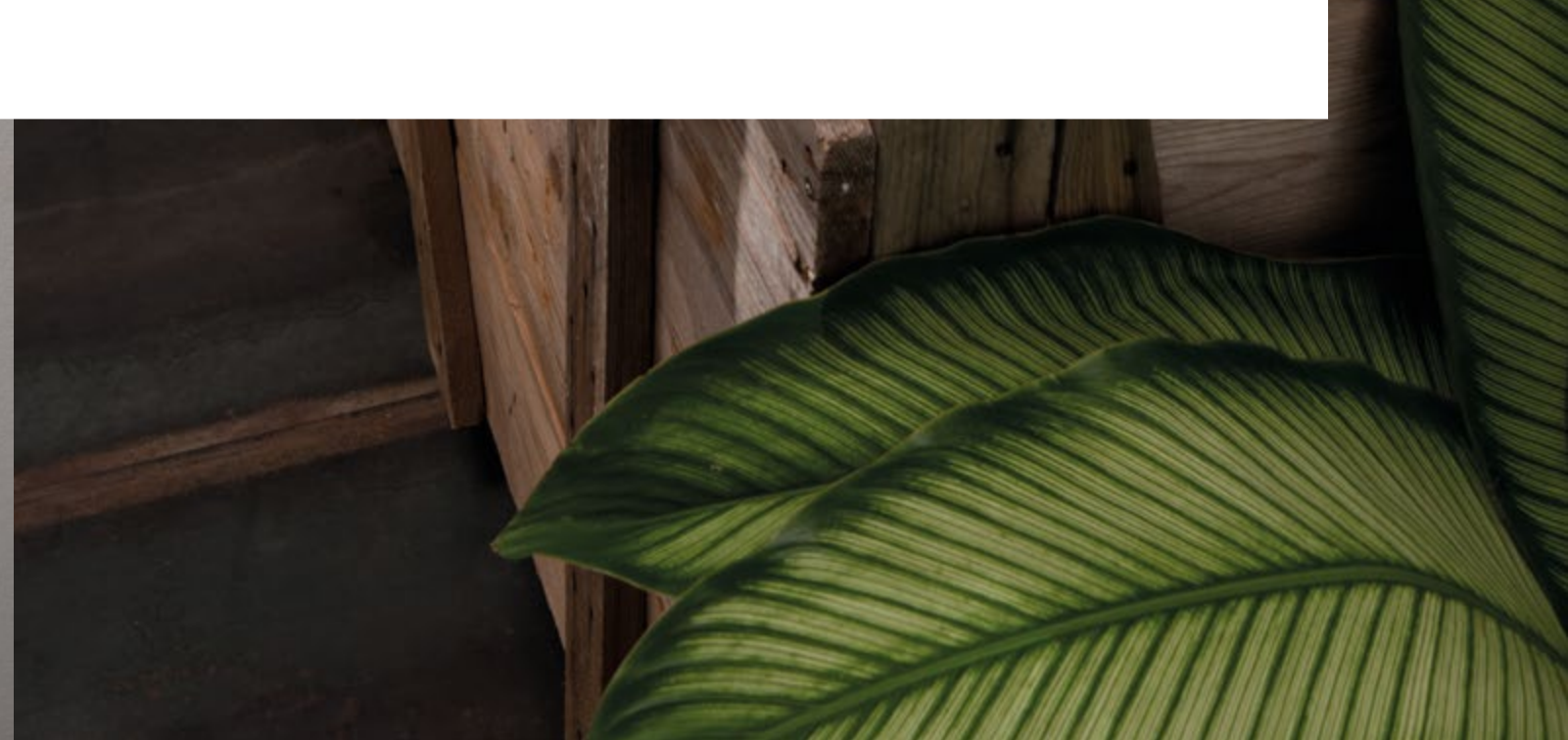



ESSENCE





ESSENCE



Características Features

El lavabo Essence permite una configuración sencilla — con un solo seno — o doble. La configuración sencilla está disponible a partir de una longitud mínima de 60cm, y permite seleccionar la ubicación de seno deseada, a izquierda, derecha o centrada. Adicionalmente, es posible elegir una posición exacta del centro del seno.

A partir de la medida mínima de 60cm, el lavabo Essence se confecciona con una longitud total “b” en función de las necesidades del cliente.

También es posible configurar el lavabo Essence con un agujero para grifo monomando o sin agujero.

El lavabo Essence se puede instalar directamente sobre encimera o en voladizo, apoyado sobre escuadras o chasis en función de la resistencia y rigidez del muro.

Existen 6 materiales diferentes a elegir, Golden Noir, Soft Grey, Dijon, Calacatta, Magnia y Jurassic, así como 3 acabados disponibles, pulido, lether y apomazado.

The Essence model is available as a single-bowl or dual-bowl sink. The single-bowl model requires a minimum length of 60 cm and offers different bowl configurations: left, right or centered. In addition, the exact position of the drain can also be specified.

With the 60 cm minimum as a starting point, the Essence sink is then customized to a total length of “b” based on the individual needs of the customer.

The Essence sink comes with either a single hole for a mixer tap or without a tap hole.

The Essence sink can sit directly on the counter or be mounted to the wall, with either brackets or a console for support, depending on the strength and solidity of the wall.

The model is available in a choice of 6 different materials – Golden Noir, Soft Grey, Dijon, Calacatta, Magnia and Jurassic – and 3 different finishes: polished, lether and honed.

Medidas Sizes

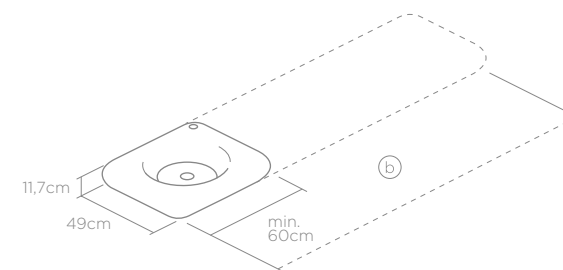

Opciones de configuración Configuration options



Materiales Materials

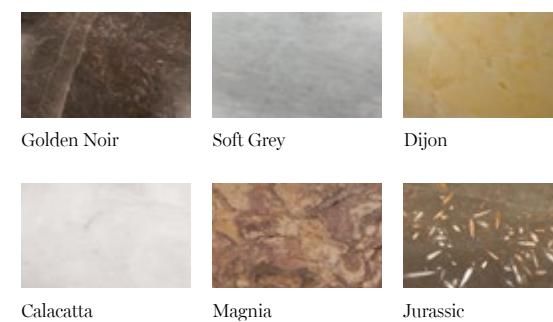

Acabados disponibles en pulido, lether y apomazado
Available finishes: polished, lether and honed

Otros materiales disponibles bajo pedido
Other materials available as special order

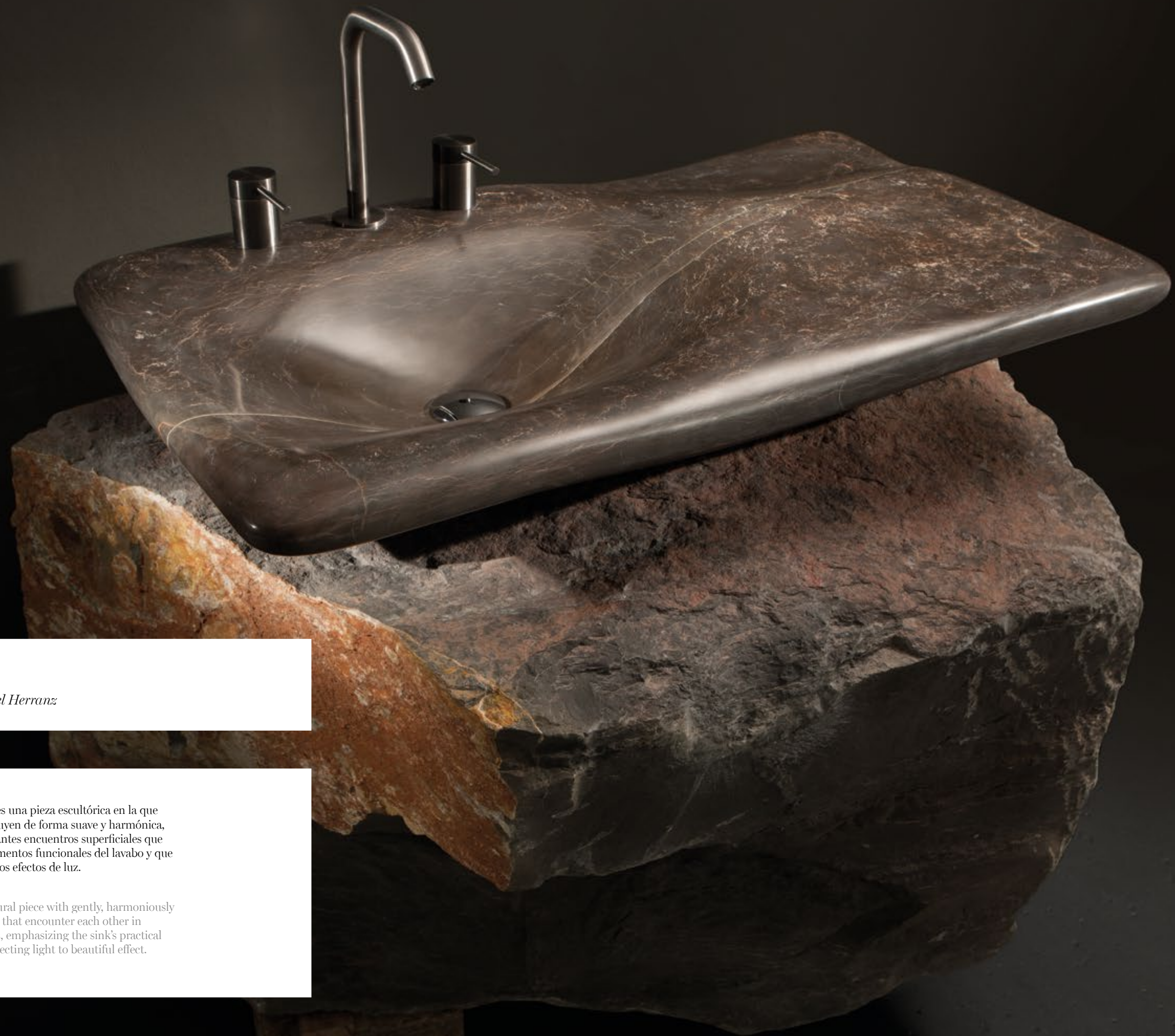

FLOW

design: Miguel Herranz

El lavabo Flow es una pieza escultórica en la que las superficies fluyen de forma suave y armónica, creando interesantes encuentros superficiales que destacan los elementos funcionales del lavabo y que generan atractivos efectos de luz.

Flow is a sculptural piece with gently, harmoniously flowing surfaces that encounter each other in fascinating ways, emphasizing the sink's practical features and reflecting light to beautiful effect.

FLOW

Su particular diseño genera un aspecto ligero ofreciendo, sin embargo, una amplia superficie de encimera. Por otro lado, el retranqueo de la base permite apoyar este lavabo sobre encimeras de 35 cm de profundidad, lo que le convierte en una pieza clave para espacios reducidos.

The unusual design gives the sink a graceful lightweight appearance while supplying plenty of countertop space. In addition, the slightly recessed base allows the sink to rest on countertops that are only 35 cm deep, making it an ideal solution for small spaces.





FLOW



Resulta muy interesante el cambio de aspecto desde diferentes puntos de vista, siempre manteniendo un carácter escultórico. El hecho de que se cree un plano elevado, además de aligerar visualmente la pieza, genera un hueco inferior que cobra valor funcional para dejar pequeños objetos.

What is particularly interesting is how the sink's appearance shifts depending on the vantage point, although it always stays true to its sculptural character. The fact that one area is elevated creates a small hollow that provides a practical solution for leaving small objects, as well as conveying an impression of lightness.





El mecanizado mediante robot de esta pieza consigue resaltar la nobleza y la pureza proveniente del bloque original, desvelando a través de su volumen la esencia natural de la piedra.

A través del mecanizado mediante robot se consigue enfatizar el volumen de partida en piedra natural.

The robotic machining of the piece brings out the elegance and purity of the original block, with its form revealing the natural essence of the stone.

Robotic machining makes it possible to emphasize the original volume of the natural stone.

FLOW

FLOW



La amplia gama de piedras que ofrece Nerinea abre un abanico de posibilidades a la hora de confeccionar el lavabo, confiriéndole una personalidad diferente según la piedra utilizada.

El lavabo Flow se ofrece tanto en versión de sobremesa como de pared.

Nerinea provides a wide selection of natural stone, which opens up myriad possibilities when it comes to crafting the sink, with each choice of stone revealing a different personality.

The Flow sink is available in both vessel and wall-mounted versions.

FLOW



FLOW



Características Features

El lavabo Flow permite seleccionar la ubicación de seno deseada, a izquierda o a derecha.

También es posible configurar el lavabo Flow con un agujero para grifo monomando, con tres agujeros para grifo y mandos o sin agujero.

El lavabo Flow se puede instalar directamente sobre encimera o en voladizo, apoyado sobre escuadras o chasis en función de la resistencia y rigidez del muro.

Existen 6 materiales diferentes a elegir, Golden Noir, Soft Grey, Dijon, Calacatta, Magnia y Jurassic, así como 3 acabados disponibles, pulido, lether y apomazado.

The Flow sink allows for a customized bowl configuration, offset either to the left or right.

The model can be configured with a single hole for a mixer tap, three holes for a tap and handles or without a tap hole.

The Flow sink can sit directly on the counter or be mounted to the wall, with either brackets or a console for support, depending on the strength and solidity of the wall.

The model is available in a choice of 6 different materials – Golden Noir, Soft Grey, Dijon, Calacatta, Magnia and Jurassic – and 3 different finishes: polished, lether and honed.

Medidas Sizes

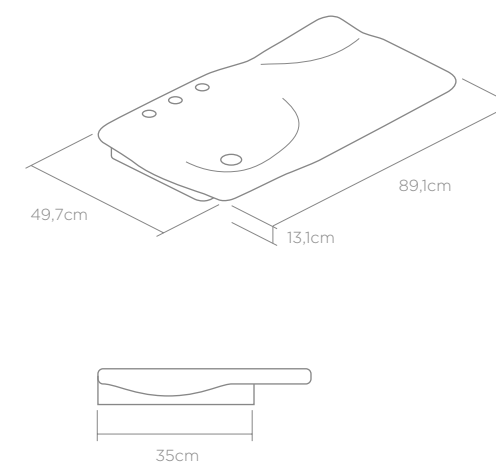

Opciones de configuración Configuration options



Materiales Materials

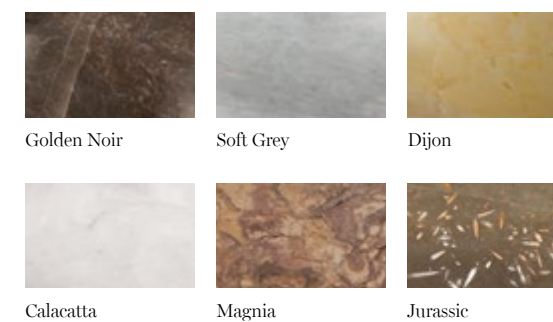

Acabados disponibles en pulido, lether y apomazado
Available finishes: polished, lether and honed

Otros materiales disponibles bajo pedido
Other materials available as special order



EROSION

design: Miguel Herranz

El lavabo Erosion es un diseño de Miguel Herranz que enfatiza la belleza de la piedra con un gesto similar al de la caricia del agua que erosiona la piedra de forma natural, configurando tanto el seno como el alojamiento del grifo.

El mecanizado mediante robot de esta pieza consigue resaltar la nobleza y la pureza proveniente del bloque original, desvelando a través de su volumen la esencia natural de la piedra.

Miguel Herranz's design for the Erosion sink emphasizes the beauty of the stone with a sculptural gesture that evokes the action of water as it gently brings about the natural process of erosion. This idea informs the design of both the basin and the faucet hole.

The robotic machining of the piece brings out the elegance and purity of the original block, with its form revealing the natural essence of the stone.



EROSION



EROSION

A través del mecanizado mediante robot se consigue enfatizar el volumen de partida en piedra natural.

Se trata de una sencilla pieza que se configura como un programa versátil que permite tres medidas de seno, pudiéndose realizar lavabos de medidas superiores con la posibilidad de descentrar el seno o incluso duplicarlo. Es decir, Essence ofrece un amplio abanico de posibilidades a medida.

Robotic machining makes it possible to emphasize the original volume of the natural stone.

Erosion is a simple piece that comes in versatile solutions. The minimum size of an individual basin is 60 cm, but the sink can be made in larger sizes with the option of placing the basin (3 sizes) off center or including two basins. Erosion thus offers a wide range of customizable features.

EROSION



EROSION





EROSION

La amplia gama de piedras que ofrece Nerinea abre un abanico de posibilidades a la hora de confeccionar el lavabo, confiriéndole una personalidad diferente según la piedra utilizada. Se ofrece tanto en versión de sobremesa como de pared.

Nerinea provides a wide selection of natural stone, which opens up myriad possibilities when it comes to crafting the sink, with each choice of stone revealing a different personality. The Erosion sink is available in both vessel and wall-mounted versions.

EROSION



EROSION

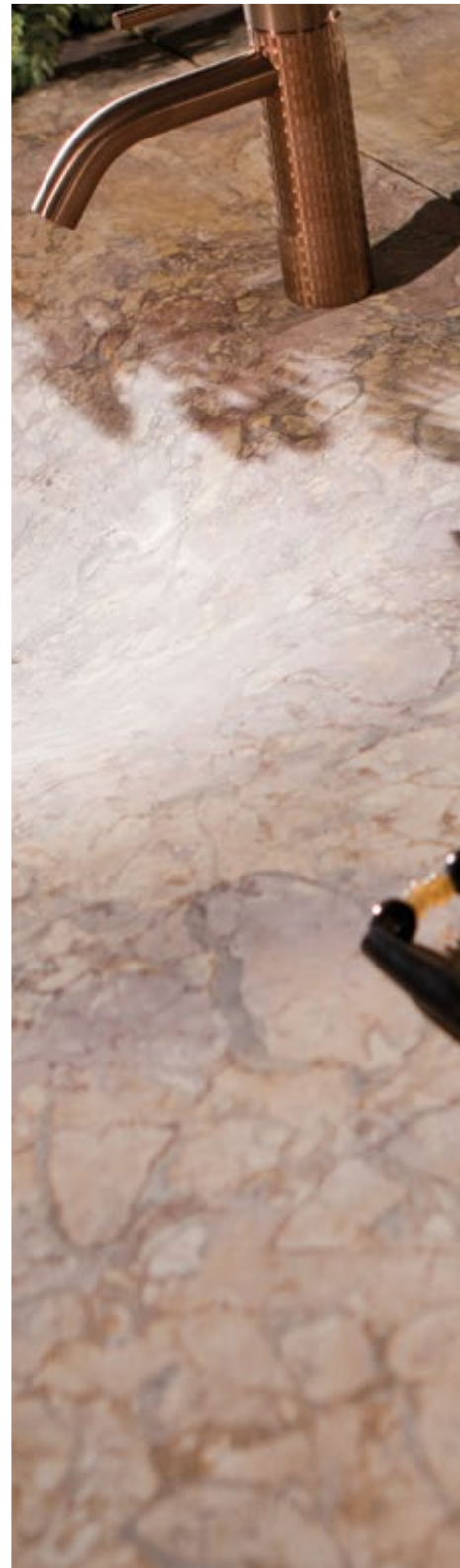

Características Features

La gama de lavabos Erosion dispone de tres tamaños de seno, pequeño, mediano y grande, con longitudes mínimas de 60cm, 80cm y 90cm respectivamente. A partir de estos mínimos, el lavabo Erosion se confecciona con una longitud total "b" en función de las necesidades del cliente.

El lavabo Erosion permite una configuración sencilla — con un solo seno — o doble. La configuración sencilla permite seleccionar la ubicación de seno deseada, a izquierda, derecha o centrada. Adicionalmente, es posible elegir una posición exacta del centro del seno.

También es posible configurar el lavabo Erosion con tres agujeros para grifo y mandos, con un agujero para grifo monomando o sin agujero.

El lavabo Erosion se puede instalar directamente sobre encimera o en voladizo, apoyado sobre escuadras o chasis en función de la resistencia y rigidez del muro.

Existen 6 materiales diferentes a elegir, Golden Noir, Soft Grey, Dijon, Calacatta, Magnia y Jurassic, así como 3 acabados disponibles, pulido, lether y apomazado.

The Erosion range comes in three bowl sizes – small, medium and large – with minimum lengths of 60 cm, 80 cm and 90 cm, respectively. With these minimum measurements as a starting point, the Erosion sink is then customized to a total length of "b" based on the individual needs of the customer.

The Erosion model is available as a single-bowl or dual-bowl sink. The single-bowl model offers different bowl configurations: left, right or centered. In addition, the exact position of the drain can also be specified.

The Erosion model can be configured with three holes for a tap and handles, a single hole for a mixer tap or without a tap hole.

The Erosion sink can sit directly on the counter or be mounted to the wall, with either brackets or a console for support, depending on the strength and solidity of the wall.

The model is available in a choice of 6 different materials – Golden Noir, Soft Grey, Dijon, Calacatta, Magnia and Jurassic – and 3 different finishes: polished, leather and honed.

Medidas Sizes

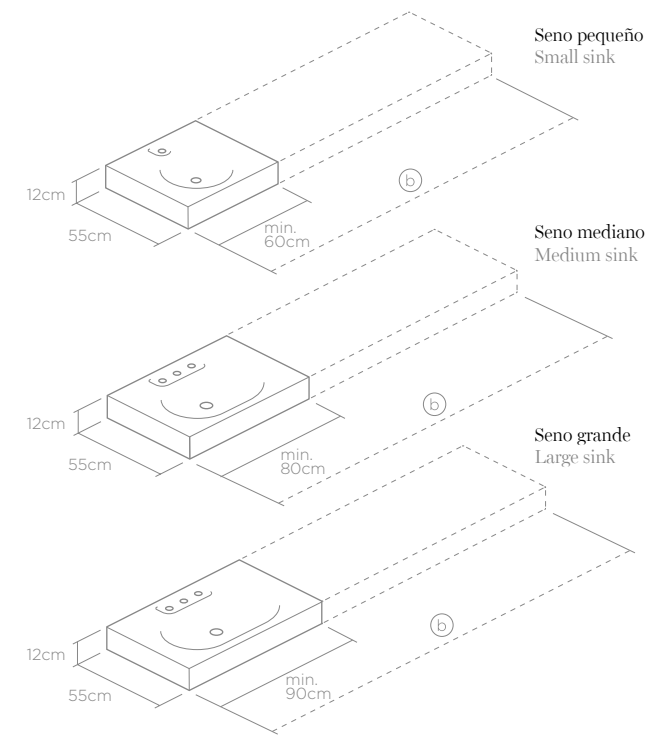

Materiales Materials

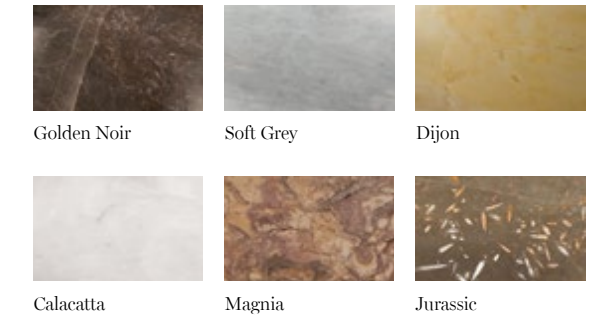

Acabados disponibles en pulido, lether y apomazado
Available finishes: polished, leather and honed

Otros materiales disponibles bajo pedido
Other materials available as special order

Opciones de configuración Configuration options

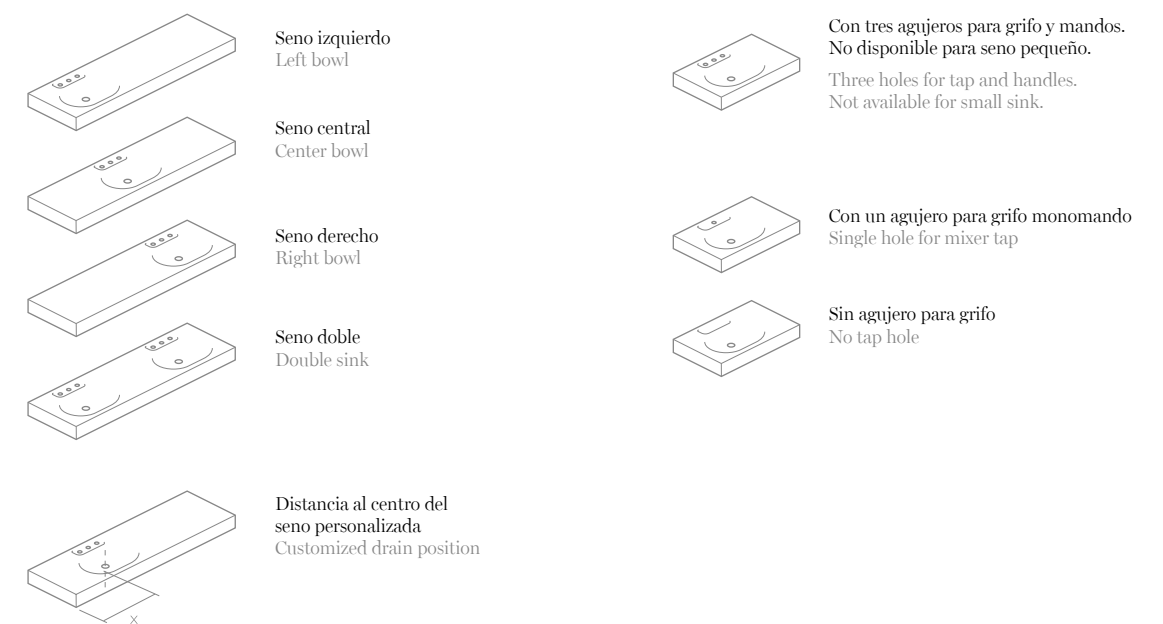



UNIQUE COLLECTION

En la cantera de Jurassic Brown -un marmol único en el mundo que comercializa en exclusiva Antolini- existen algunas piezas que, por erosión natural, presentan los fósiles de Nerineas en relieve.

In the Jurassic Brown quarry—a unique kind of marble sold exclusively by Antolini—natural erosion has caused certain stones to feature Nerinea fossils in relief.



Unique Collection, es una serie de elementos elaborados a partir de bloques de piedra, que por erosión natural, presentan en relieve fósiles de Nerineas del jurásico con una antigüedad de 150 millones de años.

Unique Collection is a series of pieces made from stone blocks where natural erosion has revealed Jurassic Nerinea fossils in relief that are 150 million years old.

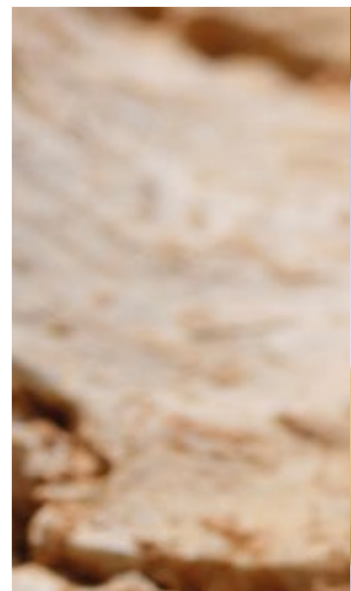

UNIQUE COLLECTION



UNIQUE COLLECTION

Cada pieza de la Unique Collection se realiza a medida, adaptándose a las necesidades del cliente y utilizando bloques que poseen formas y relieves únicos e irrepetibles que se preservan del mecanizado para mantener su valiosa belleza natural.

Every piece in the Unique Collection is custom-made according to the needs of each individual client. Chiseled out of blocks with original, one-of-a-kind forms and surface textures, the pieces are not machined to preserve their incomparable natural beauty.



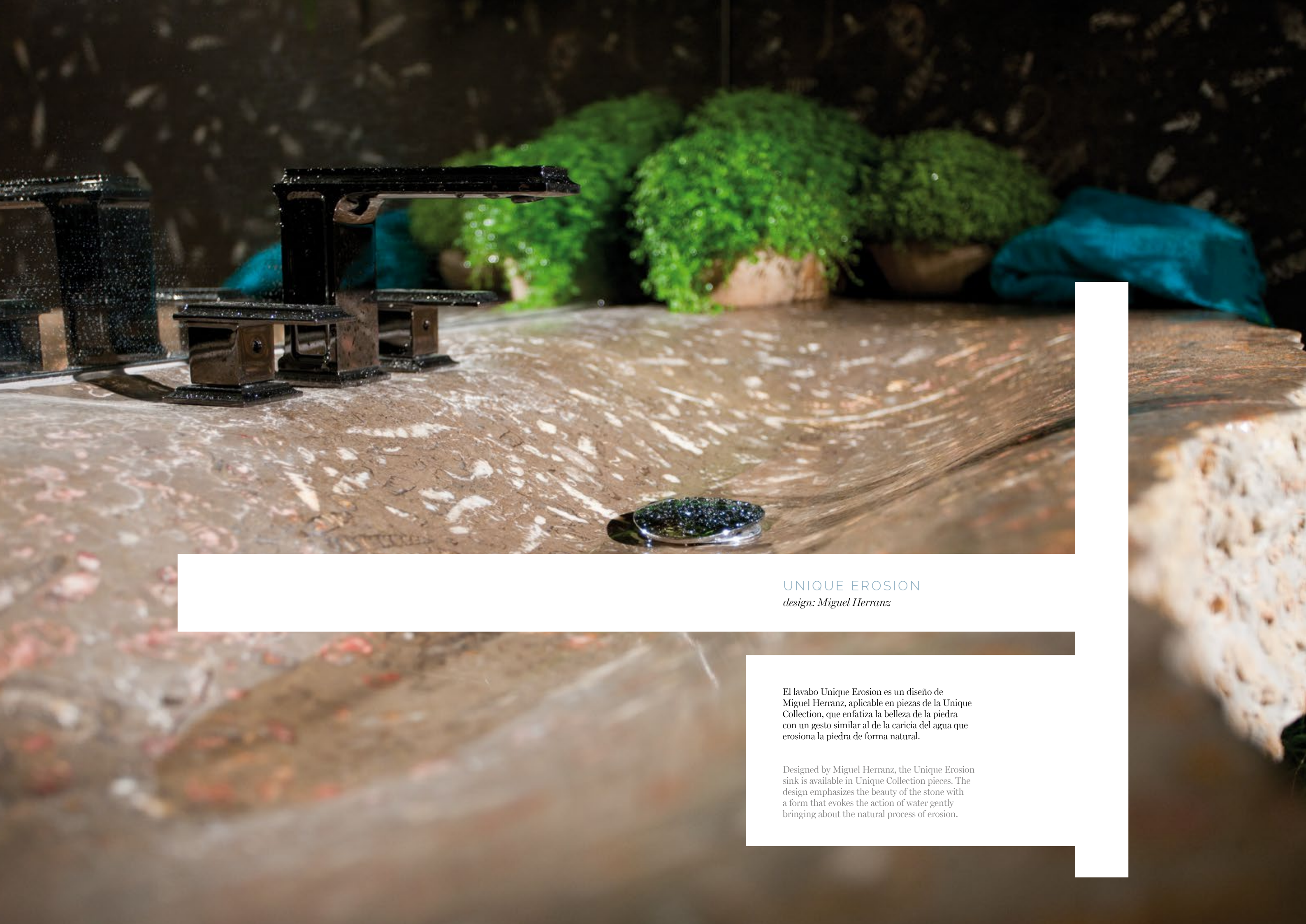

UNIQUE EROSION

design: Miguel Herranz

El lavabo Unique Erosion es un diseño de Miguel Herranz, aplicable en piezas de la Unique Collection, que enfatiza la belleza de la piedra con un gesto similar al de la caricia del agua que erosiona la piedra de forma natural.

Designed by Miguel Herranz, the Unique Erosion sink is available in Unique Collection pieces. The design emphasizes the beauty of the stone with a form that evokes the action of water gently bringing about the natural process of erosion.



UNIQUE EROSION



UNIQUE EROSION



UNIQUE EROSION



UNIQUE EROSION

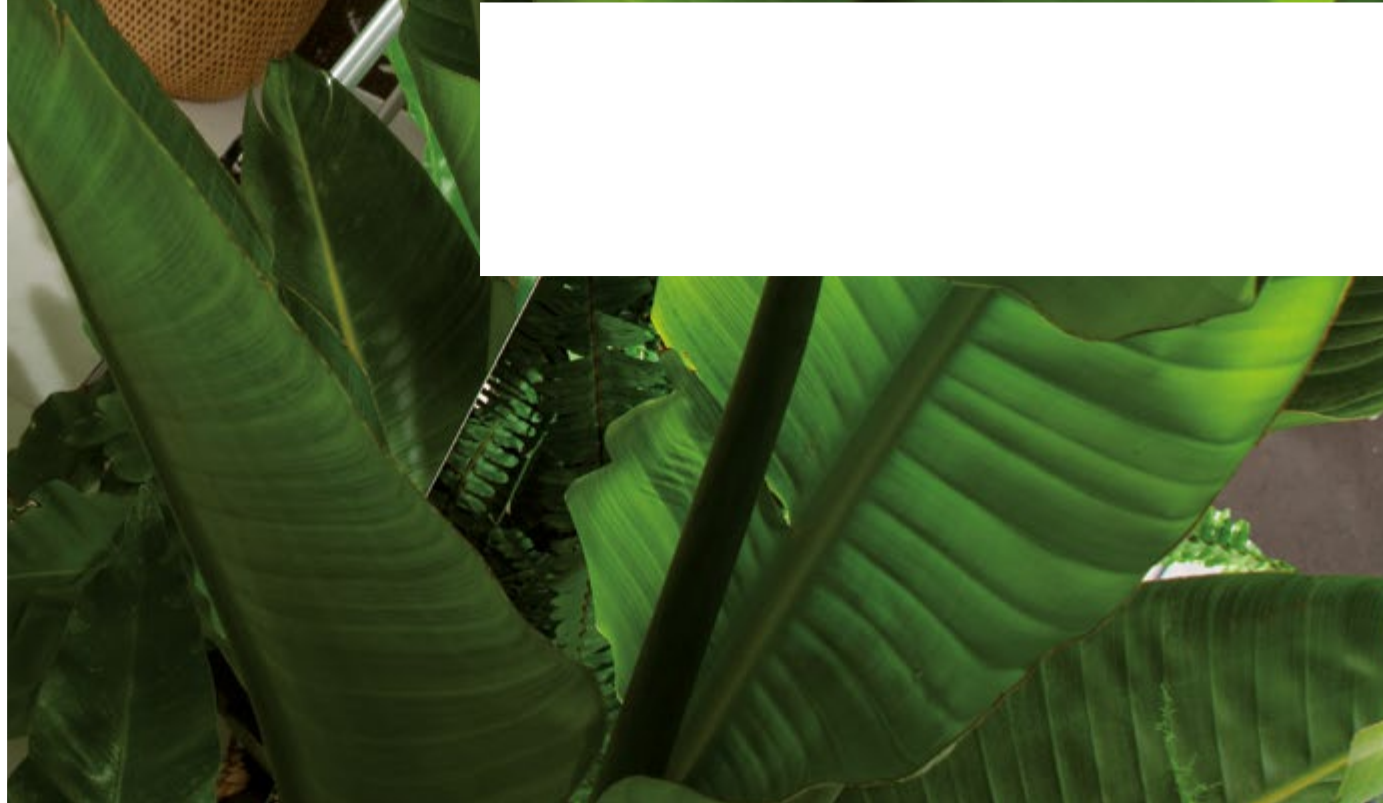

creative direction:
Miguel Herranz

graphic design:
Malo Branding

photography:
Gerald Kiernan

thanks to:
Valoffice
Gessi



NERINEA

natural stone essence

Stonepark Nerinea en:

*Vía de servicio,
A3 Valencia-Madrid salida 322
46360 Buñol, Valencia*

*+34 961 803 530
info@nerinea.com
www.nerinea.com*



Exclusiva para España de:

Antolini ITALY CITCO